



CORiTEC 350i series

The CORiTEC 350i series

WHAT ARE THE DIFFERENCES?

	COR TEC 350i		COR TEC 350i Loader		COR TEC 350i PRO ⁺	
Motor technology	Servo with encoder			Servo with absolute encoder		
Resolution	10.000 Inc (0.5 µm)			32.000 Inc (0.15 µm)		
Base structure	steel/aluminum			polymer concrete, steel rails		
Screen	12" touchscreen			15" HD touchscreen		
Housing	mat (frosted) design			shiny design, LED illumination		
Fully automatic workpiece blankchanger	manual	 12-fold	manual	 12-fold	manual	 12-fold
Blankholder inclusive	1	6	2	8	2	8
Absolute measurement system in all axes	-	-	✓	✓	✓	✓
Spindle power	1.0 kW	1.0 kW	1.0 kW	1.0 kW	2.6 kW	2.6 kW
Spindle bearing	two hybrid bearings			three hybrid bearings		
Collet	6 mm			6 mm (self cleaning)		
zero point clamping system	optional	✓	✓	✓	✓	✓
Cooling system spindle	air cooled			water cooling system		

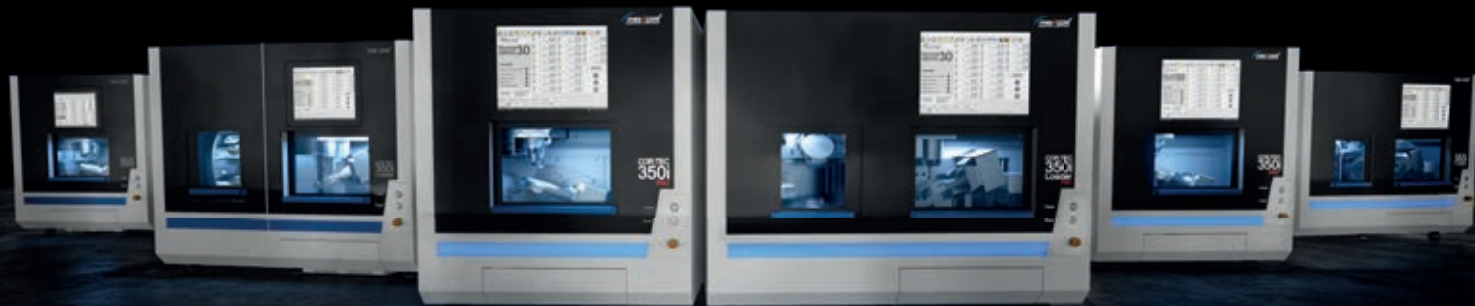

THE BUSINESS CLASS
of dental
CAD/CAM machines!



CORiTEC 350i / 350i Loader

THE AUTOMATED ALL-IN-ONE SOLUTION

The CORiTEC 350i processing system is an innovative machine concept, developed to meet any requirements of modern CAD/CAM processing. The processing of all relevant blank materials of cobalt chrome, titanium, zirconium dioxide, plastics, block materials, and new future materials is thus possible with a single machine system, virtually without restrictions.

The optional zero-point clamping system of the CORiTEC 350i allows a simple blank change of the complete blank holder at the push of a button. In addition, the zero point clamping system can be used to clamp a wide range of adapter the system can be used for a variety of applications, e.g. different PreFab abutment holders, glass ceramic holders or the C-Clamp.

The CORiTEC 350i Loader with fully automated blank magazine also enables versatile machining of up to 12 blanks in unmanned operation.

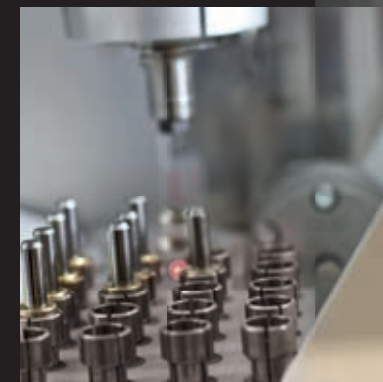
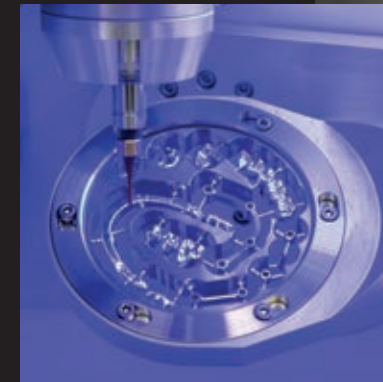
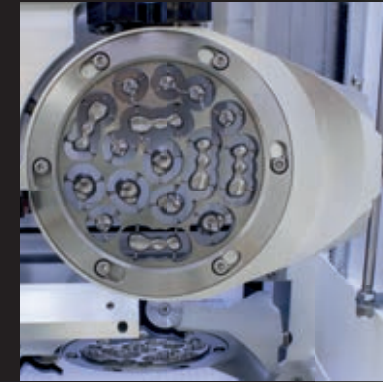

- WET
- DRY
- 5 AX
- 6 mm
20x
- Temperature icon
- Touchscreen icon
- Blank holder icon
- Blank holder icon
- 12x
- ION
optional

CORiTEC 350i

SIMPLE TOUCHSCREEN OPERATING
 20-FOLD TOOL CHANGER
 STABLE CHASSIS CONSTRUCTION
 ZERO-POINT CLAMPING SYSTEM OPTIONAL POSSIBLE
 INTEGRATED WET AND DRY PROCESSING
 INTEGRATED TEMPERATURE COMPENSATION
 OPTIONAL IONIZER POSSIBLE



PMMA	WAX
Zr	COMPOSITE
PEEK	SINT
Glass ceramics	PreFab Abutments
CoCr	Ti
Standard	C-Clamp
PreMilled Abutment	Block
Dentures	zero-point clamping system
Crowns, Bridges	Hybrid Abutment
Inlay, Onlay, Veneer	Splint
Full Denture	Drilling template
Model	Model casting
Bridge	Abutments
Telescopic technology	Hybrid machining

CORiTEC 350i Loader

FULLY AUTOMATIC 12-FOLD BLANK CHANGER
 INTEGRATED WET AND DRY PROCESSING
 ZERO POINT CLAMPING SYSTEM INTEGRATED
 AROUND THE CLOCK 24 hours production operation
 OPTIONAL IONIZER POSSIBLE
 INTEGRATED TEMPERATURE COMPENSATION



CORiTEC 350i PRO SERIES

polymer concrete
base

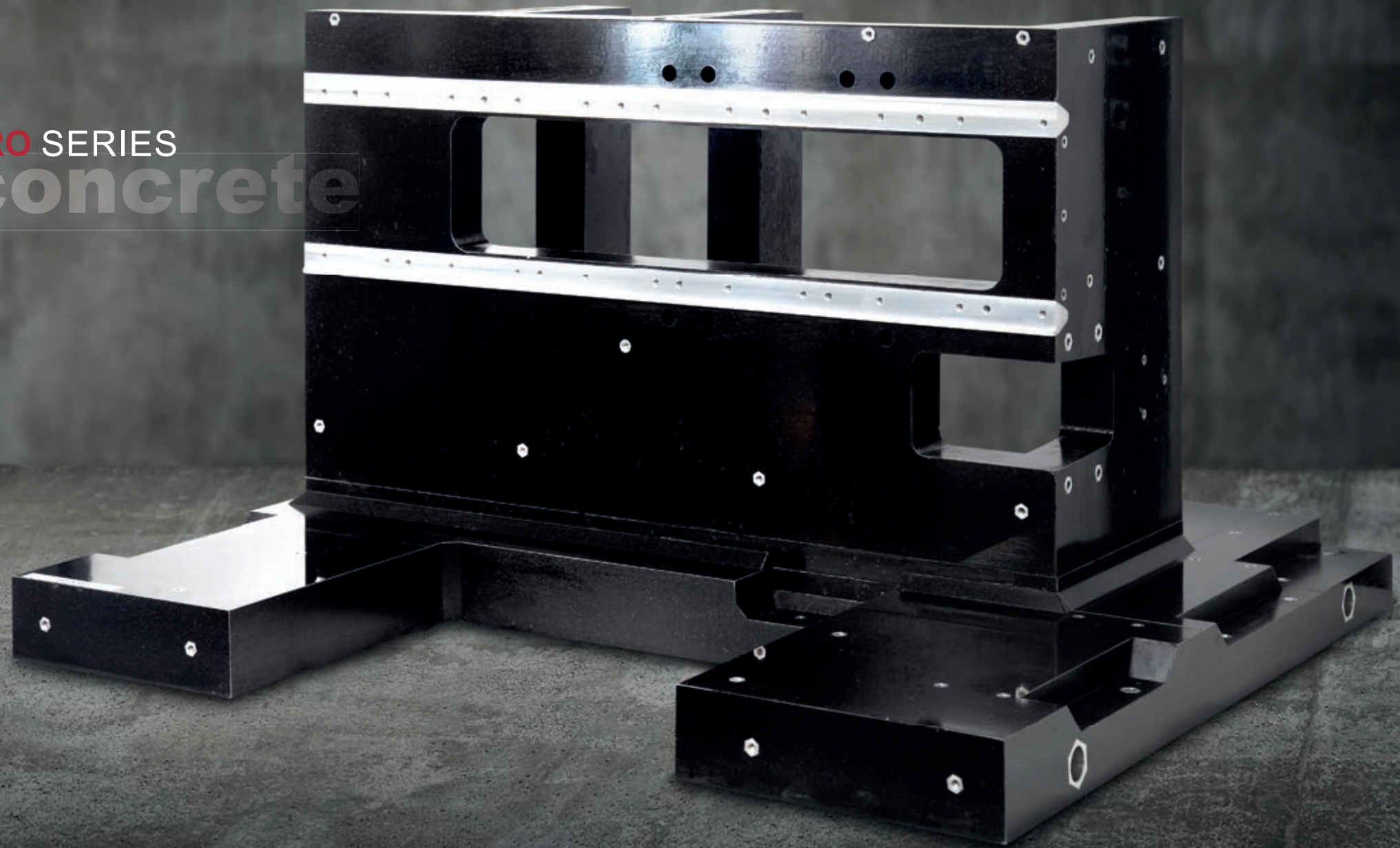

CORiTEC 350i PRO / 350i Loader PRO

THE PROFESSIONAL SOLUTION FOR HIGHEST DEMANDS

The high-resolution dynamic servo motors with absolute measuring systems used in the CORiTEC 350i PRO series guarantee up to 20 % faster machining with optimum precision.

A further advantage of the PRO series is that this machine system is constructed from a one-piece machine frame made of polymer concrete and thus guarantees the highest possible stability for vibration-free machining.

The CORiTEC 350i Loader PRO with fully automated blank magazine also enables versatile machining of up to 12 blanks in unmanned operation. Due to the precise repositioning of the zero point clamping system, different PreFab abutment holders can be used.

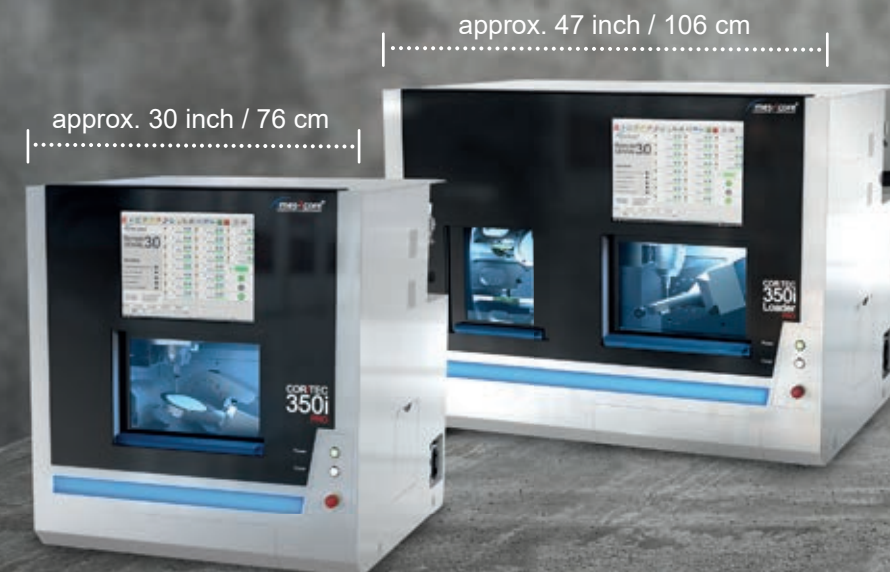

- WET
- DRY
- 5 AX
- 6 mm / 20x
- Temperature icon
- Touchscreen icon
- Mobile device icon
- 12x
- ION optional

CORiTEC 350i PRO

ALL CAD/CAM MATERIALS
CAN BE PROCESSED

15 INCH
TOUCHSCREEN

REVOLUTIONARY
BASE STRUCTURE
OF POLYMER
CONCRETE

INTEGRATED TEMPERATURE
COMPENSATION



INTEGRATED
WET AND DRY
PROCESSING

ABSOLUTE MEASURING
SYSTEM IN ALL AXES

ZERO-POINT
CLAMPING
SYSTEM
STANDARD

20-FOLD
TOOL CHANGER

PMMA	WAX
Zr	COMPOSITE
PEEK	SINT
Glass ceramics	PreFab Abutments
CoCr	Ti
Standard	C-Clamp
PreMilled Abutment	Block
Dentures	zero-point clamping system
Crowns, Bridges	Hybrid Abutment
Inlay, Onlay, Veneer	Splint
Full Denture	Drilling template
Model	Model casting
Bridge	Abutments
Telescopic technology	Hybrid machining

CORiTEC 350i Loader PRO

FULLY AUTOMATIC
12-FOLD BLANK CHANGER

USE OF DIFFERENT ADAPTER SYSTEMS
e.g. prefabricated abutments or block materials

NEW, HIGH-DYNAMIC SERVO DRIVES
for up to 20 % quicker processing

INTEGRATED
WET AND DRY
PROCESSING

AROUND THE CLOCK
24 hours of production

ZERO POINT
CLAMPING
SYSTEM

OPTIONAL
IONIZER
POSSIBLE

INTEGRATED
TEMPERATURE
COMPENSATION



CORiTEC 350i PRO⁺ / 350i Loader PRO⁺

THE PLUS OF PERFORMANCE AND PRECISION

As already implemented in the CORiTEC 350i PRO, the CORiTEC 350i PRO⁺ series also comes with high-resolution dynamic servo motors and absolute measuring systems. To use this advanced technology and to be able to fully exploit its full potential, the CORiTEC 350i PRO⁺ is equipped with a water-cooled, powerful 2.6 kW spindle with 3-fold hybrid ball bearing (water-cooled). Reaching the stability and reducing vibrations is given by the massive stainless steel blank holders.

The water cooling ensures a constant temperature of the milling spindle, so thermal expansion of the milling spindle is significantly minimized and enables even more precise milling results.

The CORiTEC 350i Loader PRO⁺ with fully automated blank magazine also enables the versatile machining of up to 12 blanks in unmanned operation.

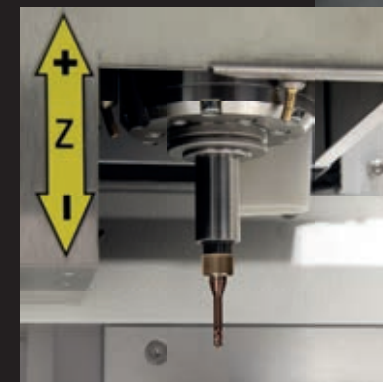
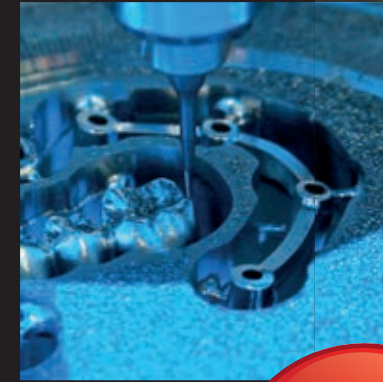

Zero-point clamping system for massive stainless steel blank holder



- WET
- DRY
- 5 AX
- 6 mm / 20x
- Temperature icon
- Touchscreen icon
- Blank holder icon
- 12x
- ION optional

CORiTEC 350i PRO⁺



HIGH-RESOLUTION DYNAMIC SERVO MOTORS with absolute measuring system

INTEGRATED WET AND DRY PROCESSING

20-FOLD TOOL CHANGER

OPTIONAL IONIZER POSSIBLE



STAINLESS STEEL BLANK HOLDER

INTEGRATED TEMPERATURE COMPENSATION

PMMA	WAX		
Zr	COMPOSITE		
PEEK	SINT		
Glass ceramics	PreFab Abutments		
CoCr	Ti		
Standard	C-Clamp		
PreMilled Abutment	Block		
Dentures	zero-point clamping system		
Crowns, Bridges	Hybrid Abutment	Splint	
Inlay, Onlay, Veneer	Drilling template	Model casting	
Full Denture	Model	Abutments	Hybrid machining
Bridge	Telescopic technology		

CORiTEC 350i Loader PRO⁺

STAINLESS STEEL BLANK HOLDER

INTEGRATED WET AND DRY PROCESSING

AROUND THE CLOCK 24 hours of production

OPTIONAL IONIZER POSSIBLE



OPTIONAL IONIZER POSSIBLE

NEW, HIGH-DYNAMIC SERVO DRIVES for up to 20 % quicker processing

INTEGRATED TEMPERATURE COMPENSATION

Applications & holder

HALF-OPEN BLANK HOLDER (C-CLAMP)

- enables 5-axis machining up to 90 degrees axis adjustment
- Extension of the technical possibilities of your milling machine
- end face machining



MANUFACTURE OF DENTAL PROSTHESES

- Baltic Denture from Merz Dental
- Dentsply Sirona Dentures



PREFABRICATED ABUTMENTS

- short production times
- Production of abutments in very simple processes
- high accuracy of fit due to prefabricated implant interface

DESS
Abutmentholder



NT-Preform® Abutment
(nt-trading)



PreFace® Abutment
(Medentika)



DDSoldiConnect®
(Dental Direkt)



THERAPEUTIC SPLINTS

- Bite splints, bleaching splints
- Snoring splints, Aligners
- simple and high-quality implementation in CAD/CAM processes



HYBRID MACHINING - SINTERING AND MILLING*

- Milling post-processing of finished restorations using the SLM method
- High precision milling combined with low-cost SLM process
- compatible with most SLM systems

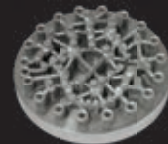

GRINDING OF CAD/CAM BLOCKS

- new 6-fold adapter enables effective production
- exchangeable strips for different adapter systems
- Crowns, onlays, inlays, veneers, bridge frameworks, etc.



IMPLANT-SUPPORTED BRIDGES AND BARS / ONE-PIECE ABUTMENTS*

- highest fitting accuracy due to new CAM technologies (ReFit)
- stress-free fit even with larger spans
- easy production due to high degree of automation with coordinated CAM software



BIOHPP ELEGANCE PREFABS

- individual hybrid abutment on PEEK basis
- BioHPP for permanent dentures, free of metal, oxide and monomer
- homogeneous combination of titanium and BioHPP



MILLING OF MODEL CASTS

- Production in combustible materials, PEEK or directly in CoCr
- allergy-free and lightweight model casting when using PEEK
- cost-efficient



MILLED IMPLANT MODELS

- DIM (Digital Implant Model) from nt-trading
- precisely positionable
- 2-part implant analog



MODEL MILLING BAUMANN SYSTEM

- Model fabrication in CAD/CAM process
- high reproducibility and precision
- Model fabrication with digital impression by intraoral scanner



*only for COR.TEC 350i PRO⁺ in preparation

T1/T6 - 3.0 | 6.0 mm
radius milling tool short (l = 15 mm)

T1	Ti
T6	CoCr

3,0 mm Ø 6 mm

up to 15 mm

Blades

Art.-No. 526026 3006

T11 - 2.5 | 6.0 mm
radius milling tool (single blade, slide coated)

T11	PMMA
	WAX
	PEEK

2,5 mm Ø 6 mm

up to 25 mm

Blade

Art.-No. 526004 2506c

T14/T41/T51 - 1.0 | 6.0 mm
radius milling tool (diamond coated)

T14	Zr
T41	SINT
T51	COMP

1,0 mm Ø 6 mm

up to 25 mm

Blades

Art.-No. 526013 1006

T19 - 0.5 | 6.0 mm
shaft milling tool (l = 4 mm)

T19	UNIVERSAL
-----	-----------

0,5 mm Ø 6 mm

up to 15 mm

Blades

Art.-No. 526001 0506

T2/T7 - 2.0 | 6.0 mm
radius milling tool short (l = 12 mm)

T2	Ti
T7	CoCr

2,0 mm Ø 6 mm

up to 15 mm

Blades

Art.-No. 526026 2006

T11/T13 - 2.5 | 6.0 mm
radius milling tool

T11	PMMA
T13	WAX
	Zr

2,5 mm Ø 6 mm

up to 25 mm

Blades

Art.-No. 526019 2506

T15/T42/T52 - 0.6 | 6.0 mm
radius milling tool (conical)

T15	PMMA
	WAX
	Zr
T42	SINT
T52	COMP

0,6 mm Ø 6 mm

up to 25 mm

Blades

Art.-No. 526019 0606

T20 - 0.6 | 6.0 mm
radius milling tool (conical)

T20	Ti
	CoCr

0,6 mm Ø 6 mm

up to 15 mm

Blades

Art.-No. 526003 0606

T3/T8 - 1.5 | 6.0 mm
radius milling tool short (l = 12 mm)

T3	Ti
T8	CoCr

1,5 mm Ø 6 mm

up to 15 mm

Blades

Art.-No. 526026 1506

T12 - 1.0 | 6.0 mm
radius milling tool (single blade, slide coated)

T12	PMMA
	WAX
	PEEK

1,0 mm Ø 6 mm

up to 25 mm

Blade

Art.-No. 526004 1006c

T16/T28 - 1.5 | 6.0 mm
radius milling tool long (l = 15 mm)

T16	PMMA
	WAX
	Zr
T28	Ti
	CoCr

1,5 mm Ø 6 mm

up to 25 mm

Blades

Art.-No. 526027 1506

T21 - 2.5 | 6.0 mm
radius milling tool (diamond)

T21	glass ceramics
-----	----------------

2,5 mm Ø 6 mm

Blades

Art.-No. 526005 2506

T4/T9 - 1.0 | 6.0 mm
radius milling tool short (l = 9 mm)

T4	Ti
T9	CoCr

1,0 mm Ø 6 mm

up to 15 mm

Blades

Art.-No. 526026 1006

T12/T14 - 1.0 | 6.0 mm
radius milling tool

T12	PMMA
T14	WAX
	Zr

1,0 mm Ø 6 mm

up to 25 mm

Blades

Art.-No. 526019 1006

T17 - 1.5 | 6.0 mm
shaft milling tool (l = 15 mm)

T17	PMMA
	WAX
	Zr

1,5 mm Ø 6 mm

up to 25 mm

Blades

Art.-No. 526001 1506

T22 - 1.0 | 6.0 mm
radius milling tool (diamond)

T22	glass ceramics
-----	----------------

1,0 mm Ø 6 mm

Blades

Art.-No. 526005 1006

T5/T10 - 1.5 | 6.0 mm
shaft milling tool short (l = 12 mm, four blades)

T5	Ti
T10	CoCr

1,5 mm Ø 6 mm

up to 15 mm

Blades

Art.-No. 526002 1506

T13/T40/T50 - 2.5 | 6.0 mm
radius milling tool (diamond coated)

T13	Zr
T40	SINT
T50	COMP

2,5 mm Ø 6 mm

up to 25 mm

Blades

Art.-No. 526013 2506

T18 - 0.5 | 6.0 mm
radius milling tool (l = 4 mm)

T18	UNIVERSAL
-----	-----------

0,5 mm Ø 6 mm

up to 15 mm

Blades

Art.-No. 526026 0506

T23 - 0.6 | 6.0 mm
radius milling tool (conical, diamond)

T23	glass ceramics
-----	----------------

0,6 mm Ø 6 mm

Blades

Art.-No. 526005 0606

T26 - 3.0 | 6.0 mm
radius milling tool long (l = 20 mm)

T26

Ti
CoCr

3,0 mm Ø 6 mm

16-20 mm

Blades



Art.-No. 526027 3006

T33/ T43/ T53 - 0.3 | 6.0 mm
radius milling tool (conical)

T33

PMMA
WAX
Zr
SINT
COMP

T43
T53

0,3 mm Ø 6 mm

up to 25 mm

Blades



Art.-No. 526019 0306

T63 - 1.5 | 6.0 mm
torus milling tool (r = 0,08 mm, l = 7 mm, two blades)

T63

Ti
CoCr

1,5 mm Ø 6 mm

up to 15 mm

Blades



Art.-No. 526025 1506

T81 - 1.5 | 6.0 mm
drilling tool (l = 18 mm)

T81

Ti
CoCr

1,5 mm Ø 6 mm

up to 20 mm

Drill

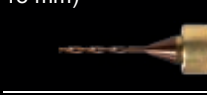

Art.-No. 526023 1506

T27 - 2.0 | 6.0 mm
radius milling tool long (l = 16 mm)

T27

Ti
CoCr

2,0 mm Ø 6 mm

16-20 mm

Blades

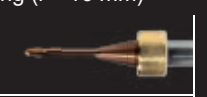

Art.-No. 526027 2006

T34 - 3.0 | 6.0 mm
radius milling tool long (l = 27 mm)

T34

PMMA
WAX

3,0 mm Ø 6 mm

up to 30 mm

Blades



Art.-No. 526012 3006

T64 - 1.5 | 6.0 mm
torus milling tool (r = 0,08 mm, l = 15 mm, two blades)

T64

Ti
CoCr

1,5 mm Ø 6 mm

up to 15 mm

Blades

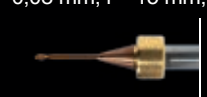

Art.-No. 526028 1506

T98 - 2.5 | 6.0 mm
shaft milling tool (l = 20 mm, three blades)

T98

CALIBR.

2,5 mm Ø 6 mm

Blades

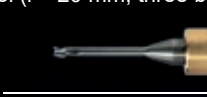

Art.-No. 526024 2506

T29 - 1.0 | 6.0 mm
radius milling tool long (l = 11 mm)

T29

Ti
CoCr

1,0 mm Ø 6 mm

16-20 mm

Blades



Art.-No. 526027 1006

T35 - 2.0 | 6.0 mm
radius milling tool long (l = 20 mm)

T35

PMMA
WAX

2,0 mm Ø 6 mm

up to 30 mm

Blades



Art.-No. 526012 2006

T67 - 2.0 | 6.0 mm
shaft milling tool short (l = 7 mm, four blades)

T67

Ti
CoCr

2,0 mm Ø 6 mm

up to 15 mm

Blades



Art.-No. 526002 2006

T30 - 4.0 | 6.0 mm
shaft milling tool long (l = 32 mm, single blade, slide coated)

T30

PMMA
WAX
PEEK

4,0 mm Ø 6 mm

up to 30 mm

Blade

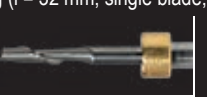

Art.-No. 526012 4006

T61 - 3.0 | 6.0 mm
Quattro speed milling tool (l = 15 mm)

T61

Ti
CoCr

3,0 mm Ø 6 mm

up to 15 mm

Blades



Art.-No. 526025 3006

T68 - 1.5 | 6.0 mm
shaft milling tool long (l = 15 mm, four blades)

T68

UNIVERSAL

1,5 mm Ø 6 mm

16-20 mm

Blades

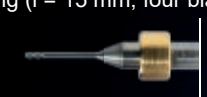

Art.-No. 526021 1506

T32 - 0.6 | 6.0 mm
radius milling tool long (l = 12 mm)

T32

PMMA
WAX
Zr

0,6 mm Ø 6 mm

up to 25 mm

Blades



Art.-No. 526012 0606

T62 - 2.0 | 6.0 mm
torus milling tool (r = 0,2 mm, l = 16 mm, four blades)

T62

Ti
CoCr

2,0 mm Ø 6 mm

up to 15 mm

Blades

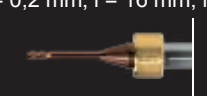

Art.-No. 526025 2006

T80 - 2.5 | 6.0 mm
drilling tool (l = 22 mm)

T80

Ti
CoCr

2,5 mm Ø 6 mm

up to 20 mm

Drill



Art.-No. 526023 2506



CORiTEC Materials

CORiTEC ZR (ZIRCONIUM DIOXIDE)

Covers all indications for dental restorations of up to 16 units.
Ideally suited for monolithic restorations.

- highly translucent zirconium dioxide for natural esthetics
- increased strength compared to lithium dioxide

Zr ht+ Disc
(highly translucent)



Zr Disc

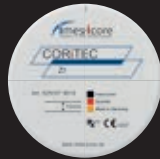

Zr transpa Disc

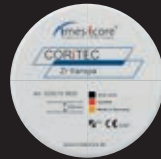

Zr transpa Disc
(pre-colored translucent)

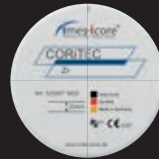

CORiTEC ZR (ZIRCONIUM DIOXIDE)

- single crowns
- single cap
- bridges up to 16 units, full bridges, and PFM technology
- good mechanical properties
- good milling properties
- corrosion resistant

CoCr Disc
(non-precious alloy)

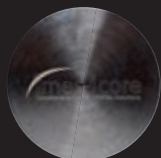

CoCr Mo Disc
(non-precious alloy)



Ti Disc
(Grade 2, Grade 4, Grade 5)



CORiTEC MODEL DISC IVORY

- Blank for the production of dental models
- low-cost material
- also suitable for test purposes or for milling calibration bodies



JUVORA PEEK (POLYETHERETHERKETONE)

- clamp-retained constructions
- Juvora PEEK in its basic colour (brown-beige)
- highest biological compatibility

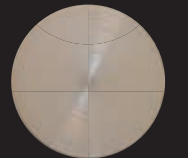

CORiTEC WAX DISC (WAX, GRAY)

CORiTEC Wax Disc is not suitable for intraoral application.
After milling, the material can be used as lost wax.
Moulds can be used in casting technology.
It can be milled easily and combusted residue-free.



CORiTEC PMMA (POLYMETHYL METHACRYLATE)

- bite guards, therapeutic splints, drilling templates, bite regulators
- very good mechanical properties
- aesthetic shade effect due to high translucency
- good milling behaviour

PMMA Splint Disc



PMMA Disc

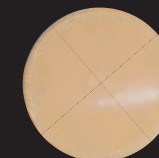

Scanner COMPATIBLE WITH **exocad**

CORiTEC i3Dscan eco

- all-round carefree package for newcomers or small laboratories
- simple, fast, low-priced
- very compact design

CORiTEC i3Dscan color

- the object to be scanned is automatically guided into the measuring field
- modern touch control design
- the 180-degree opening offers a large working area

CORiTEC i3Dscan color HR

- enormously high scanning efficiency and precision (4 µm)
- Color Texture scan
- Blue-Light LED & High resolution camera (2.8 MP)
- all modules included in the scope of delivery



CAM software

CORiTEC iCAM V4.7

- all strategies optimized for 5-axis simultaneous machining
- 64-bit multi-core support
- no annual license fees
- validated post-processors for all imes-icore® CORiTEC machines

CORiTEC iCAM V5

- all strategies optimized for 5-axis simultaneous machining
- automatic exchange of implant connections (ReFit option)
- no annual license fees
- fully automatic and easy operation with "Wizard Workflow"

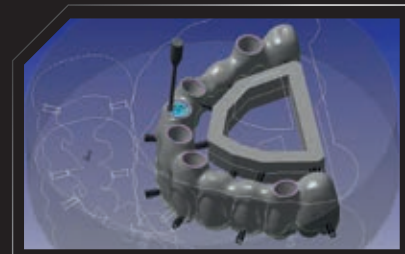

Machine tables

The undercounters, specially developed for the needs of the various machine types, impress with their sturdy design as well as their attractive appearance. The machine tables have sufficient floor space. Stable rollers ensure optimum stability and easy movement of the devices. Drawers, cable ducts and a cabinet for the integration of appropriate extraction systems are already provided.

Machine Table T1	Machine Table T2
30.3 x 36.6 x 31.1 inch 770 x 930 x 790 mm W x H x D	41.7 x 36.6 x 31.1 inch 1060 x 930 x 790 mm W x H x D
CORiTEC 350i CORiTEC 350i PRO CORiTEC 350i PRO+	CORiTEC 350i Loader CORiTEC 350i Loader PRO CORiTEC 350i Loader PRO+



Suction systems

	iVAC eco+	iVAC silent PRO	iVAC pro+	iCompVAC*
Volume flow	260m³/hr	240 m³/hr	280m³/hr	160m³/hr
Output	1200 W	1610 W	1200 W	1300 W
Filter system	dust drawer, HEPA filter	Teflon Filterpatrone, automatische Abreinigung	Teflon filter cartridge, automatic cleaning feature	dust drawer, HEPA filter
Filter volume	25 liters	8 Liter	15 liters	25 liters
W x D x H	7.3 x 18.1 x 29.5 inch 440 x 460 x 750 mm	10.6 x 21.2 x 21.1 inch 270 x 540 x 535 mm	13.7 x 13.7 x 39.3 inch 350 x 350 x 1000 mm	18.5 x 25.1 x 34.6 inch 470 x 640 x 880 mm
Supply voltage	115 V/230 V	115 V/230 V	115 V/230 V	230 V

*not designed for continuous operation



Sintering Furnaces

iSINT eco

The **iSINT eco** stands for economy and offers high-quality technology, matching accessories for high standards at a fair price. Compact and with a small footprint, the **iSINT eco** sintering oven still has sufficient capacity for a sintering bowl Ø 100 mm for approx. 25 units. The door stop can be mounted right and left.

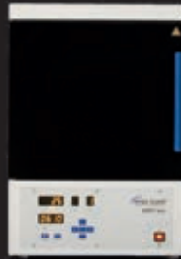

iSINT PRO

A larger sintering capacity of up to 80 single crowns is offered by the new **iSINT PRO**. With a heating system with four high-quality molybdenum disilicide (MoSi₂) heating elements, you can choose between conventional long-term sintering or SPEED sintering at a rate of up to 99 °C/minute. The **iSINT PRO** is controlled by a simple and convenient program control. The programs are displayed on a 4-line LCD display. A timer function for overnight sintering or the use of pre-drying programs for shaded zirconium restorations offer further options. In addition, three service programs are available for easy maintenance of the sinter furnace.

	iSINT eco	iSINT PRO
Number of heating elements	4	4
Display	7-Segment	4-line LCD
Number of program memories	9	30
Combustion chamber capacity	1 x 100	2 x 120
max. heating rate in °C/min	30	99
Power in W	1720	3200
Lift function	No	Yes
Speedsintering	No	Yes

Dimensions

CORiTEC 350i series

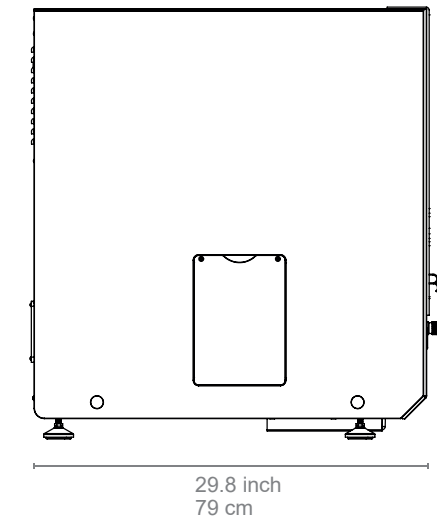
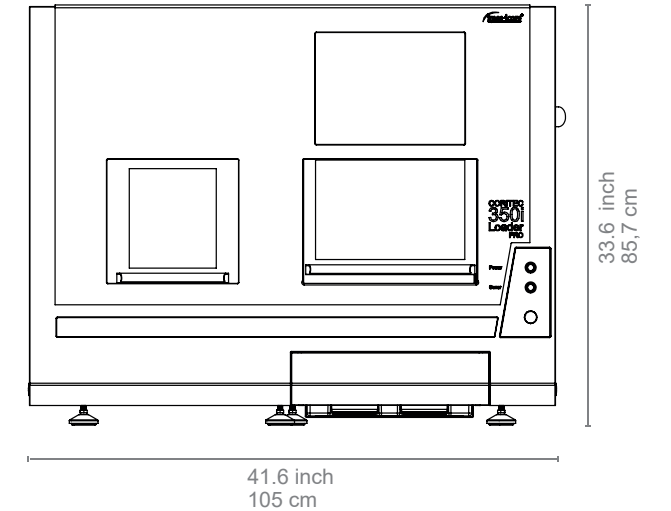
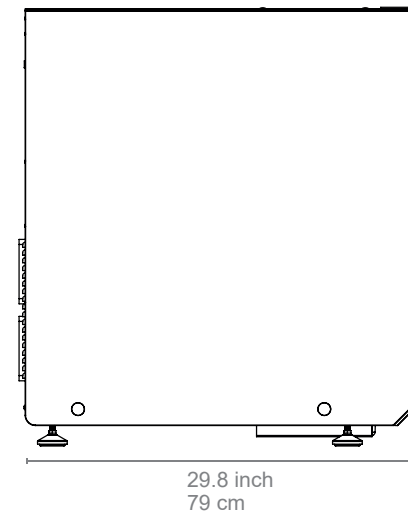
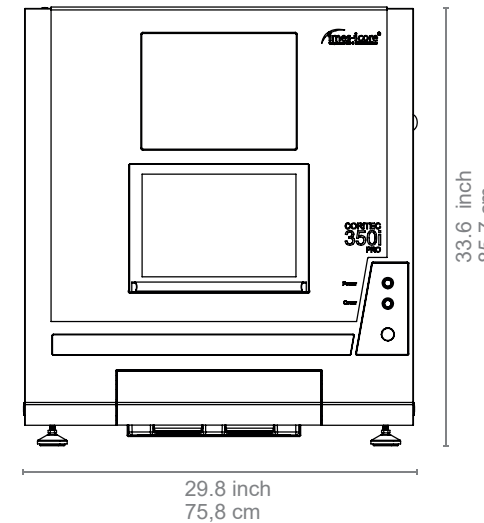

CORiTEC 350i series in numbers

	CORiTEC 350i	CORiTEC 350i Loader	CORiTEC 350i PRO	CORiTEC 350i Loader PRO	CORiTEC 350i PRO ⁺	CORiTEC 350i Loader PRO ⁺
mechanics / electronics						
base structure	steel / aluminum	steel / aluminum	polymer concrete	polymer concrete	polymer concrete	polymer concrete
number of axes and operation type	5 axes, simultaneous machining	5 axes, simultaneous machining	5 axes, simultaneous machining	5 axes, simultaneous machining	5 axes, simultaneous machining	5 axes, simultaneous machining
rotation angle	A-axis 360°, B-axis 115°	A-axis 360°, B-axis 115°	A-axis 360°, B-axis 115°	A-axis 360°, B-axis 115°	A-axis 360°, B-axis 115°	A-axis 360°, B-axis 115°
spindle	high-frequency spindle	high-frequency spindle	high-frequency spindle	high-frequency spindle	high-frequency spindle	high-frequency spindle
maximum spindle speed / spindle power	60.000 rpm 1.0 kW	60.000 rpm 1.0 kW	60.000 rpm 1.0 kW	60.000 rpm 1.0 kW	60.000 rpm 2.6 kW	60.000 rpm 2.6 kW
spindle cooling	air cooled	air cooled	air cooled	air cooled	water cooled	water cooled
zero point clamping system	optional	Yes	Yes	Yes	Yes	Yes
blankchanger	-	up to 12 blanks	-	up to 12 blanks	-	up to 12 blanks with stainless steel holder
tools	milling and grinding tools with 6 mm shaft	milling and grinding tools with 6 mm shaft	milling and grinding tools with 6 mm shaft	milling and grinding tools with 6 mm shaft	milling and grinding tools with 6 mm shaft	milling and grinding tools with 6 mm shaft
tool changer	20-times	20-times	20-times	20-times	20-times	20-times
tool length control	≤ 0.002 mm precision	≤ 0.002 mm precision	≤ 0.002 mm precision	≤ 0.002 mm precision	≤ 0.002 mm precision	≤ 0.002 mm precision
integrated PC	Windows based	Windows based	Windows based	Windows based	Windows based	Windows based
monitor	integrated 12" touchscreen	integrated 12" touchscreen	integrated 15" touchscreen	integrated 15" touchscreen	integrated 15" touchscreen	integrated 15" touchscreen
illumination	3 LED status colors / LED illumination	3 LED status colors / LED illumination	3 LED status colors / LED illumination	3 LED status colors / LED illumination	3 LED status colors / LED illumination	3 LED status colors / LED illumination
software	Remote DENTAL 3.0	Remote DENTAL 3.0	Remote DENTAL 3.0	Remote DENTAL 3.0	Remote DENTAL 3.0	Remote DENTAL 3.0
air pressure	6.5 - 9 bar constantly supply, 80 liters/minute	6.5 - 9 bar constantly supply, 80 liters/minute	6.5 - 9 bar constantly supply, 80 liters/minute	6.5 - 9 bar constantly supply, 80 liters/minute	6.5 - 9 bar constantly supply, 80 liters/minute	6.5 - 9 bar constantly supply, 80 liters/minute
cooling liquid	4.8 liter integrated	4.8 liter integrated	4.8 liter integrated	4.8 liter integrated	4.8 liter integrated	4.8 liter integrated
connecting requirements						
weight	180 kg	225 kg	205 kg	250 kg	210 kg	255 kg
width x depth x height	29.8 x 31.1 x 33.7 inch 758 x 790 x 857 mm	46.6 x 31.1 x 33.7 inch 1058 x 790 x 857 mm	29.8 x 31.1 x 33.7 inch 758 x 790 x 857 mm	46.6 x 31.1 x 33.7 inch 1058 x 790 x 857 mm	29.8 x 31.1 x 33.7 inch 758 x 790 x 857 mm	46.6 x 31.1 x 33.7 inch 1058 x 790 x 857 mm
line voltage / frequency	100 V - 240 V / 50/60 Hz	100 V - 240 V / 50/60 Hz	100 V - 240 V / 50/60 Hz	100 V - 240 V / 50/60 Hz	110 V - 50/60 Hz 230 V - 50/60 Hz	110 V - 50/60 Hz 230 V - 50/60 Hz

Sales and support partner worldwide



Represented for you in over 100 countries.

imes-icore® GmbH has been a leading manufacturer and technology partner since 2003 in the field of dental CAD/CAM systems and solutions.

With your unique range of dental milling and grinding systems imes-icore® offers a perfect selection for all individual requirements of dental laboratories, milling centres and dental practices of all sizes.

Our “Open-System” product philosophy makes it possible to easily integrate our milling machines into your existing workflow and to integrate them with your open scanners and your CAD/CAM software. We are open for your material selection.

imes-icore® GmbH

Fon +49 (0) 66 72/898 228

Fax +49 (0) 66 72/898 222

dental@imes-icore.de